

Product Specification

モデル名	A1W2-01250
全光束(lm)	1260 lm
消費電力	12W
力率	> 0.9
高効率(lm/W)	105 lm/W
色温度(K)	5000K
演色性(Ra)	> 80
照射角	125°
定格入力電圧(V)	100 - 277Vac
使用温度	-20°C~50°C
※ Tolerance Range : ± 10%	

Product Description

- System Input Power: 12W
- Efficacy: 105 lm/W
- Input Frequency(Hz): 50/60Hz

Dimensions(mm)

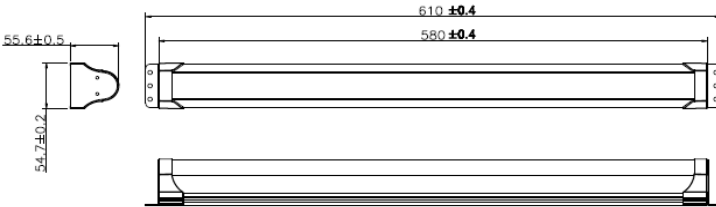

Physical Info

サイズ(mm)	610 x 55 x 56
発光面(mm)	581
製品重量	< 580g

Light Distribution & Distance Luminary - A1W2-01250

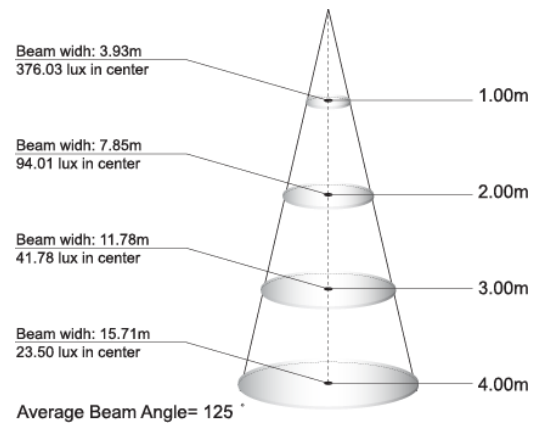
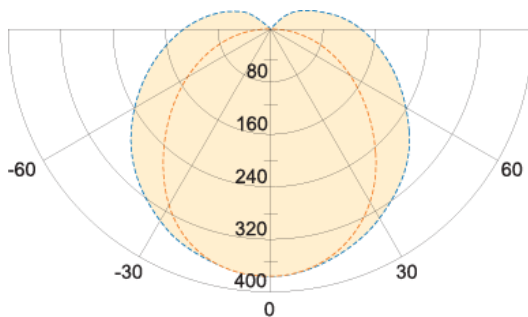



Product Specification

モデル名	A1W4-01850
全光束(lm)	1870 lm
消費電力	18W
力率	> 0.9
高効率(lm/W)	104 lm/W
色温度(K)	5000K
演色性(Ra)	> 80
照射角	125°
定格入力電圧(V)	100 - 277Vac
使用温度	-20°C~50°C
※ Tolerance Range : ± 10%	

Product Description

- System Input Power: 18W
- Efficacy: 104 lm/W
- Input Frequency(Hz): 50/60Hz

Dimensions

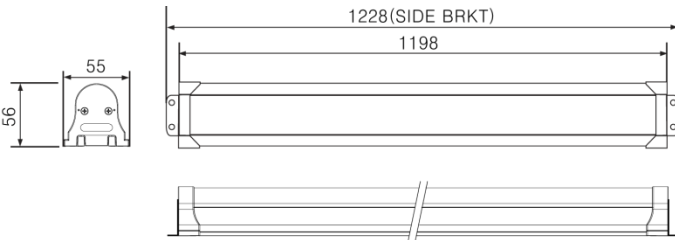

Physical Info

サイズ(mm)	1198 x 55 x 56
発光面(mm)	1169
製品重量	< 850g

Light Distribution & Distance Luminary - A1W4-01850

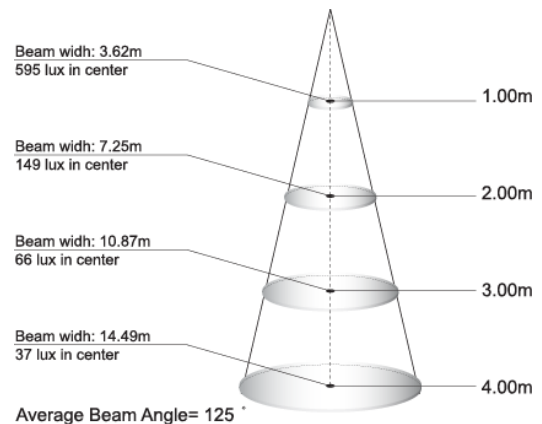
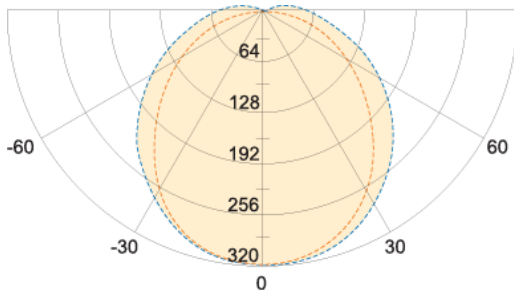



Product Specification

モデル名	A1W4-02350
全光束(lm)	2400 lm
消費電力	23W
力率	> 0.9
高効率(lm/W)	104 lm/W
色温度(K)	5000K
演色性(Ra)	> 80
照射角	125°
定格入力電圧(V)	100 - 277Vac
使用温度	-20°C~50°C
※ Tolerance Range : ± 10%	

Product Description

- System Input Power: 23W
- Efficacy: 104 lm/W
- Input Frequency(Hz): 50/60Hz

Dimensions

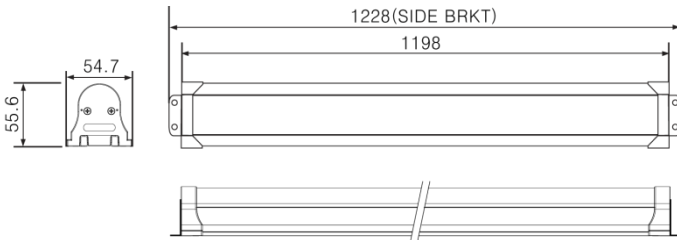

Physical Info

サイズ(mm)	1198 x 55 x 56
発光面(mm)	1169
製品重量	< 850g

Light Distribution & Distance Luminary - A1W4-02350

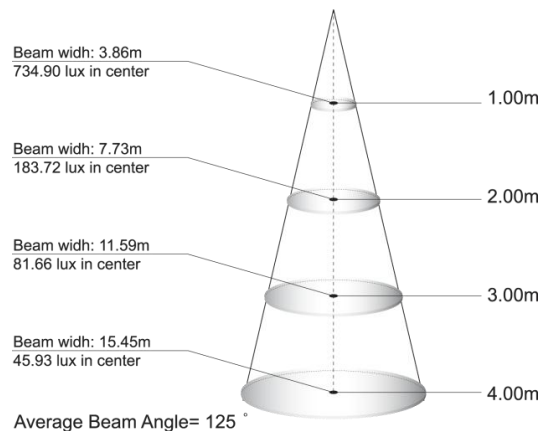
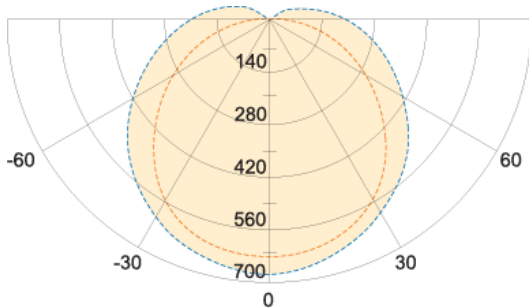



Product Description

- System Input Power: 12W
- Efficacy: 104 lm/W
- Input Frequency(Hz): 50/60Hz
- IP 65

Dimensions

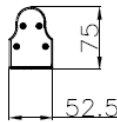
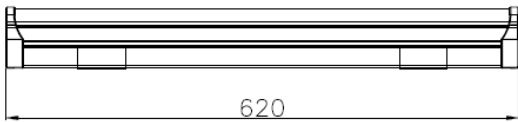
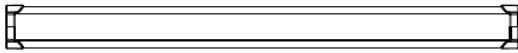

Product Specification

モデル名	A1W2I-01250
全光束(lm)	1248 lm
消費電力	12W
力率	> 0.9
高効率(lm/W)	104 lm/W
色温度(K)	5000K
演色性(Ra)	> 80
照射角	125°
定格入力電圧(V)	100 - 277Vac
使用温度	-20°C~50°C

※ Tolerance Range : ± 10%

Physical Info

サイズ(mm)	620 x 53 x 75
発光面(mm)	598
製品重量	< 580g

Light Distribution & Distance Luminary - A1W4I-01250

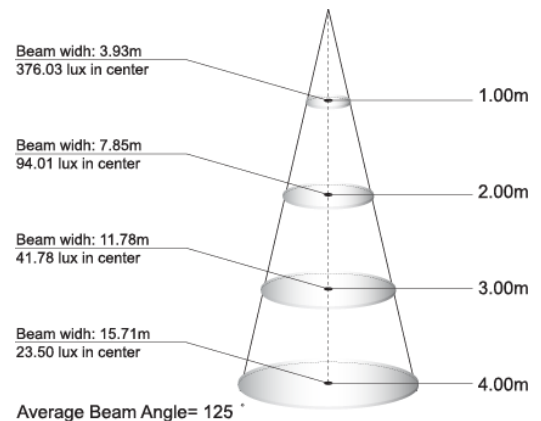
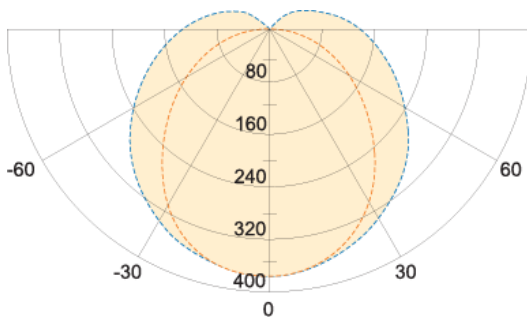



Product Description

- System Input Power: 21W
- Efficacy: 104 lm/W
- Input Frequency(Hz): 50/60Hz
- IP 65

Dimensions

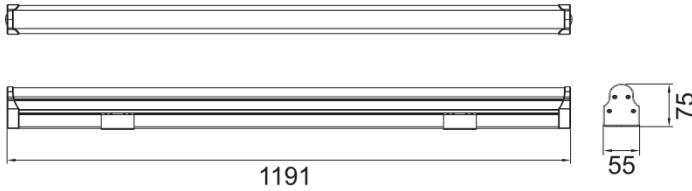

Product Specification

モデル名	A1W4I-02150
全光束(lm)	2180 lm
消費電力	21W
力率	> 0.9
高効率(lm/W)	104 lm/W
色温度(K)	5000K
演色性(Ra)	> 80
照射角	125°
定格入力電圧(V)	100 - 277Vac
使用温度	-20°C~50°C

※ Tolerance Range : ± 10%

Physical Info

サイズ(mm)	1191 x 55 x 75
発光面(mm)	1169
製品重量	< 850g

Light Distribution & Distance Luminary - A1W4I-02150

